

acar

2017

ACAR - FIRMA

Firma ACAR S.A. działa w branży elektrycznej i elektrotechnicznej od 1990 roku. Oferujemy zaawansowane rozwiązania techniczne. Cechuje nas innowacyjność, profesjonalizm i otwartość na zmiany.

„Jakość. Technologia. Bezpieczeństwo” stanowi motto we wszystkich aspektach działalności przedsiębiorstwa. Prowadzimy twardą selekcję partnerów i dostawców komponentów.

Jesteśmy wiarygodnym partnerem biznesowym.

Oferata firmy ACAR S.A. to produkcja własna przedłużaczy elektrycznych, przewodów przyłączeniowych, listw zasilających oraz dystrybucja wysokiej jakości osprzętu elektroinstalacyjnego.

Wszystkie produkty ACAR wytwarzane są zgodnie z systemami zarządzania jakością ISO 9001:2008 oraz spełniają europejskie standardy.

ACAR - COMPANY

ACAR has been present on electrical and electrotechnical market since 1990. We offer advanced technical solutions. We are innovative, professional and open to changes.

„Quality, technology, safety” is our motto in all aspects of company operation. We are very demanding in terms of our choice of business partners and suppliers selection.

We are reliable business partner.

ACAR is manufacturer of extension cords and power cords and distributor of surge protectors and high quality electrical equipment.

All ACAR products are made according to ISO 9001:2008 Quality management systems and meet European standards.

ACAR - PORTFEL MAREK / COMPANY'S BRANDS

Linia przedłużaczy specjalistycznych, produkowanych w Polsce, z najwyższej jakości komponentów, dla najbardziej wymagających użytkowników.

Line of power cords for professionals, manufactured in Poland from the highest quality of components, directed for the most demanding users

Linia produktów dla użytkowników ceniących jakość, do wykorzystania w gospodarstwach domowych, w przydomowych warsztatach czy w ogrodach.

Line of products for users who value quality, for home use, house workshops and gardens.

Linia produktów dobrej jakości i w rozsądnej cenie.

Line of products of good quality and reasonable prices.

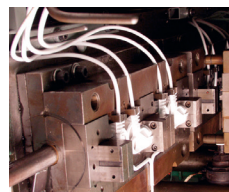
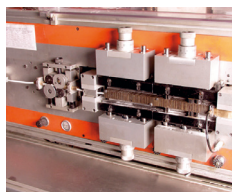

DLACZEGO ACAR?

WYSOKA JAKOŚĆ KOMPONENTÓW

Do produkcji naszych przedłużaczy używamy wyłącznie wysokiej jakości przewodów. Najwyższa jakość gniazd i wtyczek przy wykorzystaniu mostków firmy Taller.

INNOWACYJNOŚĆ

Nasze produkty cechuje przede wszystkim funkcjonalność i wyjątkowy design. Wdrażamy nowoczesne rozwiązania techniczne oraz kładziemy nacisk na dbałość o detale.

POLSKA PRODUKCJA

Wspieramy rozwój polskiej gospodarki, tworzymy nowe miejsca pracy.

ISO 9001:2008

ACAR S.A. wprowadził i nieustannie doskonali politykę zarządzania jakością potwierdzoną certyfikatem ISO. Świadczy to o wysokim standardzie produkcji oraz spełnieniu wszystkich wymogów jakościowych i technologicznych.

WHY ACAR?

HIGH QUALITY OF COMPONENTS

We only use the highest quality of cable in order to manufacture extension cords. The highest quality of plugs and sockets is maintained thanks to Taller inserts.

INNOVATION

Our products are characterized by their functionality and exceptional design. We implement modern technical solutions and take special care for details.

POLISH PRODUCTION

We support development of Polish economy and create new work places.

ISO 9001:2008

ACAR introduced and has developed politics of quality management confirmed by ISO certificate. It proves high standard of production and meeting quality and technological requirements.



LEGENDA / LEGEND



GNIAZDO Z UCHEM
SOCKET WITH AN EYE



GNIAZDO BEZ UZIEMIENIA
SOCKET WITHOUT GROUNDING



GNIAZDO PŁASKIE
FLAT SOCKET



WTYCZKA Z UCHEM
PLUG WITH AN EYE



WTYCZKA BEZ UZIEMIENIA
PLUG WITHOUT GROUNDING



WTYCZKA PŁASKA
FLAT PLUG



KLAPKA ZABEZPIEZAJĄCA
PROTECTIVE COVER



GNIAZDO Z UZIEMIENIEM
SOCKET WITH GROUNDING



GNIAZDO KOMPUTEROWE
COMPUTER SOCKET



WYŁĄCZNIK
SWITCH



WTYCZKA Z UZIEMIENIEM
PLUG WITH GROUNDING



PRODUKT DOSTĘPNY W WERSJI SCHUKO
PRODUCT AVAILABLE IN SCHUKO TYPE



UZIEMIENIE
GROUNDING



GNIAZDO Z UZIEMIENIEM – SCHUKO
SOCKET WITH GROUNDING – SCHUKO



NOWOŚĆ
NEW

STOSOWANE MOSTKI / INSERTS



EKSPOZYTORY / PROMOTIONAL STANDS

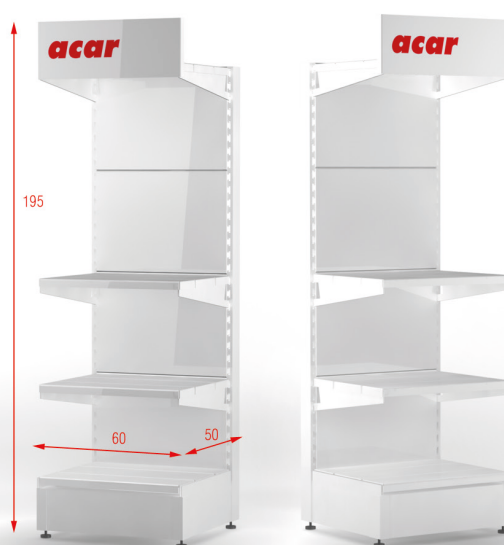



1.1 PRZEDŁUŻACZE OGRODOWE
GARDEN EXTENSION CORDS

1.2 PRZEDŁUŻACZE BĘBNOWE
CABLE REELS



PS-2P

PRZEDŁUŻACZ Z POJEDYNCZYM GNIAZDEM I WTYCZKĄ BEZ UZIEMIENIA
EXTENSION CORD WITH SINGLE SOCKET AND PLUG, WITHOUT GROUNDING



PS-US

PRZEDŁUŻACZ Z POJEDYNCZYM GNIAZDEM I WTYCZKĄ Z UZIEMIENIEM
EXTENSION CORD WITH SINGLE SOCKET AND PLUG, WITH GROUNDING

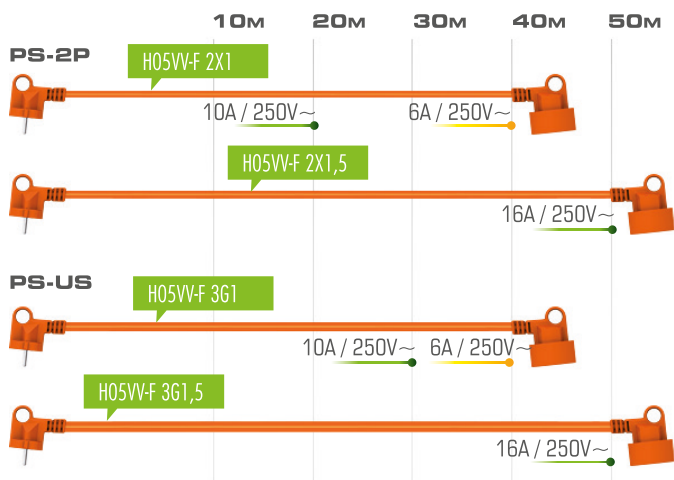

Drogi Kliencie,

nasze przedłużacze są produktem specjalnie przygotowanym do pracy na zewnątrz. Nasi projektanci wybrali tylko te przewody, których duży przekrój zapewnia poprawną pracę najbardziej wymagających urządzeń ogrodowych, a gruba powłoka zwiększa przede wszystkim bezpieczeństwo użytkowania, a także wytrzymałość na uszkodzenia.

Uwaga, ostrzegamy!!!

Drogi Kliencie, jeżeli jesteś na etapie wyboru przedłużacza ogrodowego, radzimy sprawdzić z jakiego przewodu został wykonany. Zespół naszych fachowców ostrzega przed stosowaniem na zewnątrz przedłużaczy, które wykonane są z przewodów: OMY, H03VV-F, 2X0,75, 3G0,75 (oznaczenie typu przewodu znajduje się na powłoce ochronnej).
Bezwzględnie odradzamy używania przedłużaczy, które nie mają żadnych oznaczeń na powłoce przewodu – według podstawowych norm każdy przewód powinien posiadać oznaczenie.

Dear Customer,

our extension cords are products specially designed for outdoor use. Our designers have selected only those cables which, through large cross-sectional areas, ensure reliable functioning even for the most demanding garden equipment while the thick insulation improves the safety of use and resistance to damage.

Caution, be warned!!!

Dear Customer, if you are about to select a garden extension cord we recommended you to check what cable it is made from. Our team of professionals warns you against outdoor use of extension cords which are made of OMY, H03VV, 2x0,75, 3G0,75 cables (cable type designation is printed on the insulating cover). We strongly advise you against use of extension cords with no marking on the cable jacket. According to the basic standards each cable should properly be marked.



PS-2P

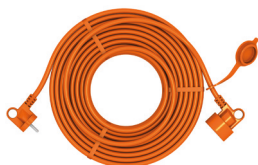

DESCRIPTION / OPIS	1 GNIAZDO, BEZ UZIEMIENIA SINGLE SOCKET, WITHOUT GROUNDING	
SOCKET TYPE / TYP		
CABLE / PRZEWÓD	2X1,5 H05VV-F (PVC)	2X1,0 H05VV-F (PVC)
MODEL / EAN	20 M 5907636001232 ● - 30 M 5907636001249 ● - 40 M 5907636001256 ● - 50 M 5907636009979 ● -	10 M 5907636001003 ● - 15 M 5907636001010 ● - 20 M 5907636001027 ● - 25 M 5907636006572 ● - 30 M 5907636001034 ● - 40 M 5907636001041 ● -

PS-US

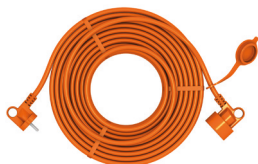

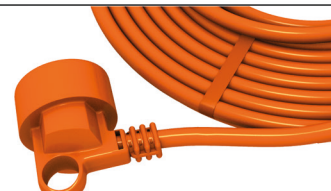
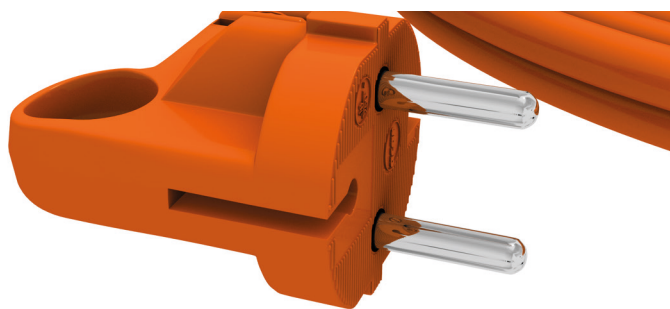

DESCRIPTION / OPIS	1 GNIAZDO, Z UZIEMIENIEM SINGLE SOCKET, WITH GROUNDING	
SOCKET TYPE / TYP		SCHUKO TYP F
CABLE / PRZEWÓD	3G1,5 H05VV-F (PVC)	3G1,0 H05VV-F (PVC)
MODEL / EAN	20 M 5907636001836 ● - 30 M 5907636001843 ● - 40 M 5907636001850 ● - 50 M 5907636001867 ● -	10 M 5907636001447 ● - 20 M 5907636001461 ● - 30 M 5907636001478 ● - 40 M 5907636001485 ● -









PZ-4Z OT



DESCRIPTION / OPIS	PRZEDŁUŻACZ BĘBNOWY, 4 GNIAZDA, TERMNIK, METALOWY STELAŻ CABLE REEL, 4 SOCKETS OUTLETS, OVERHEAT PROTECTION, METAL FRAME	
SOCKET TYPE / TYP	 x4  x4 SCHUKO TYP F	
CABLE / PRZEWÓD	3G1,5 H05VV-F (PVC)	
MODEL / EAN	40 M 5907636008927 ● -	50 M 5907636008934 ● -





PZ-4Z OTM



DESCRIPTION / OPIS	PRZEDŁUŻACZ BĘBNOWY, 4 GNIAZDA, TERMNIK, METALOWY STELAŻ CABLE REEL, 4 SOCKETS OUTLETS, OVERHEAT PROTECTION, METAL FRAME			
SOCKET TYPE / TYP	 x4  x4 SCHUKO TYP F		 x4  x4 SCHUKO TYP F	
CABLE / PRZEWÓD	3G1,5 H05VV-F (PVC)		3G1,0 H05VV-F (PVC)	
MODEL / EAN	25 M 5907437082034 ● -	35 M 5907437084069 ● -	25 M 5907636008910 ● -	-

PZ-4Z OTMM



DESCRIPTION / OPIS	PRZEDŁUŻACZ BĘBNOWY, 4 GNIAZDA, TERMNIK, METALOWY STELAŻ CABLE REEL, 4 SOCKETS OUTLETS, OVERHEAT PROTECTION, METAL FRAME			
SOCKET TYPE / TYP	 x4  x4 SCHUKO TYP F		 x4  x4 SCHUKO TYP F	
CABLE / PRZEWÓD	3G1,5 H05VV-F (PVC)		3G1,0 H05VV-F (PVC)	
MODEL / EAN	15 M 5907437082027 ● -	-	15 M 5907437082010 ● -	25 M 5907437084588 ● -



2.1 PRZEDŁUŻACZE SPECJALISTYCZNE
SPECIAL PURPOSE EXTENSION CORDS

2.2 PRZEDŁUŻACZE BĘBNOWE
CABLE REELS



PS-US

PRZEDŁUŻACZ Z POJEDYNCZYM GNIAZDEM I WTYCZKĄ Z UZIEMIENIEM
EXTENSION CORD WITH SINGLE SOCKET AND PLUG, WITH GROUNDING



Drogi Kliencie,

Przedłużacze specjalistyczne ACAR stworzone zostały z myślą o bezpieczeństwie ich użytkowania podczas remontów, w przydomowym warsztacie, na budowie.

Podstawę konstrukcji naszych produktów stanowi przewód w lekkiej oponie z syntetycznej, samogasnącej gumy. Dzięki temu przedłużacze ACAR znajdują zastosowanie w ciężkich i wymagających warunkach, w suchych i wilgotnych pomieszczeniach, jak też na zewnątrz.

Korpusy gniazd i wtyczek sieciowych wykonano z miękkiego, elastycznego materiału, co czyni je bardziej odpornymi na uszkodzenia. Monolityczna konstrukcja korpusów ogranicza przedostawanie się do wnętrza zanieczyszczeń mogących mieć wpływ na prawidłowe działanie przedłużacza. Wtyczki i gniazda sieciowe posiadają ponadto ergonomiczne uchwyty ułatwiające ich łączenie i rozłączanie.

Przedłużacze specjalistyczne bębnowe charakteryzuje funkcjonalność użytkowania - możliwość swobodnego ręcznego rozwinięcia i zwinięcia przewodu. Wyroby cechuje solidna rama nośna oraz czterokrotne gniazdo wtykowe ze stykiem ochronnym. Nawijaki zostały wyposażone w gumowy uchwyt zapobiegający przypadkowemu rozwinięciu oraz funkcję parkowania wtyczki sieciowej. Wtyczka sieciowa odznacza się ergonomiczną częścią chwytową, bocznym wyprowadzeniem przewodu oraz podwójnym układem styków ochronnych.

Przedłużacz SPIRO znajduje swoje zastosowanie w warsztatach specjalistycznych jak i przydomowym warsztacie. Stworzony został z myślą o elektronarzędziach. Największą zaletą wyrobu jest jego funkcjonalność użytkowania. Spiralny przewód podnosi wygodę i bezpieczeństwo pracy. Natychmiast dostosowuje swą długość do potrzeb użytkownika. Zabezpiecza też skutecznie przed wrywaniem przewodu zasilającego z gniazda lub rękocyfeli elektronarzędzi. Przedłużacz charakteryzuje się ergonomiczną częścią chwytową wtyczki i gniazda.

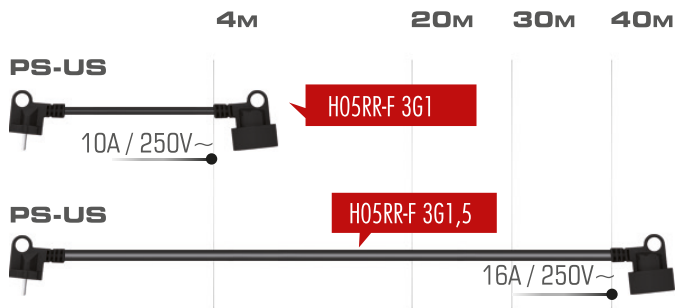

Dear Customer,

Special purpose extension cords have been created to ensure the safety of use during repairs, at home workshops or construction sites.

The design of our extension cords is based on a cable in a light, synthetic, self-extinguishing rubber insulation. This allows ACAR extension cords to be used in heavy duty conditions, inside dry or humid rooms and outdoors.

Bodies of sockets and outlet plugs are made of soft, flexible material which makes them more resistant to damage. Monolith design of bodies limits penetration of pollutants which might affect proper operation of the extension cord. Further more, mains sockets and outlet plugs are equipped with ergonomic grips which facilitate connection and disconnection.



Cable reels are distinguished by handiness as it has the possibility of easy winding and rewinding of the cord. The product features a robust load-bearing frame and a four-pronged outlet with protection contact. The reels are equipped with a rubber grip which prevents in advertent rewinding and an outlet plug parking feature. The outlet plug features a very ergonomic gripping part, side cord outlet and double protection contact system.

SPIRO extension cord is applicable at specialist workshop and at home workshop. It was created for power tools use. The largest advantage of the product is functionality of use. The spiral cable guarantees comfort and safety of the work. The length is adapted to the user's needs. The spiral cable protects also against pull out the power supply cord from a socket or from the handle of power tools. The extension cord is characterized by very ergonomic grip in socket and also in plug.





PS-US / SPIRO



DESCRIPTION / OPIS	1 GNIAZDO, Z UZIEMIENIEM SINGLE SOCKET, WITH GROUNDING		
SOCKET TYPE / TYP			SCHUKO TYP F
CABLE / PRZEWÓD	3G1,0 H05VV-F (PVC)		
MODEL / EAN	4 M	5907437086070 ●	-

PS-US







DESCRIPTION / OPIS	1 GNIAZDO, Z UZIEMIENIEM SINGLE SOCKET, WITH GROUNDING		
SOCKET TYPE / TYP			SCHUKO TYP F
CABLE / PRZEWÓD	3G1,5 H05RR-F (GUMA / RUBBER)		
MODEL / EAN	20 M	5907636004622 ●	-
	30 M	5907636001768 ●	-
	40 M	5907636004691 ●	-









PZ-4Z ST



DESCRIPTION / OPIS	PRZEDŁUŻACZ BĘBNOWY, 4 GNIAZDA, TERMIK, METALOWY STELAŻ CABLE REEL, 4 SOCKETS OUTLETS, OVERHEAT PROTECTION, METAL FRAME			
SOCKET TYPE / TYP	 x4	 x4 SCHUKO TYP F	 x4	 x4 SCHUKO TYP F
CABLE / PRZEWÓD	3G1,5 H05RR-F (GUMA / RUBBER)		3G1,5 H05VV-F (PVC)	
MODEL / EAN	40 M 5907636008958 ●	-	40 M 5907437087312 ●	-
	45 M 5907437085608 ●			
	50 M 5907437088364 ●			





PZ-4Z STM



DESCRIPTION / OPIS	PRZEDŁUŻACZ BĘBNOWY, 4 GNIAZDA, TERMIK, METALOWY STELAŻ CABLE REEL, 4 SOCKETS OUTLETS, OVERHEAT PROTECTION, METAL FRAME			
SOCKET TYPE / TYP	 x4	 x4 SCHUKO TYP F	 x4	 x4 SCHUKO TYP F
CABLE / PRZEWÓD	3G1,0 H05RR-F (GUMA / RUBBER)		-	
MODEL / EAN	25 M 5907636008941 ●	-	-	-
CABLE / PRZEWÓD	3G1,5 H05RR-F (GUMA / RUBBER)		3G1,5 H05VV-F (PVC)	
MODEL / EAN	25 M 5907437082065 ●	-	30 M 5907437087305 ●	-
	35 M 5907437087206 ●			

PZ-4Z STMM



DESCRIPTION / OPIS	PRZEDŁUŻACZ BĘBNOWY, 4 GNIAZDA, TERMIK, METALOWY STELAŻ CABLE REEL, 4 SOCKETS OUTLETS, OVERHEAT PROTECTION, METAL FRAME			
SOCKET TYPE / TYP	 x4	 x4 SCHUKO TYP F	 x4	 x4 SCHUKO TYP F
CABLE / PRZEWÓD	3G1,0 H05RR-F (GUMA / RUBBER)		3G1,0 H05VV-F (PVC)	
MODEL / EAN	15 M 5907437082041 ●	-	20 M 5907437087299 ●	-
CABLE / PRZEWÓD	3G1,5 H05RR-F (GUMA / RUBBER)		-	
MODEL / EAN	15 M 5907437082058 ●	-	-	-



- 3.1 PRZEDŁUŻACZE UNIWERSALNE
UNIVERSAL EXTENSION CORDS
- 3.2 LISTWY ZABEZPIEZAJĄCE
SURGE PROTECTORS



PS-120



PRZEDŁUŻACZ Z PŁASKIM GNIAZDEM I WTYCZKĄ BEZ UZIEMIENIA
EXTENSION CORD WITH FLAT SOCKET AND PLUG, WITHOUT GROUNDING



PS-2P



PRZEDŁUŻACZ Z POJEDYNCZYM GNIAZDEM I WTYCZKĄ BEZ UZIEMIENIA
EXTENSION CORD WITH SINGLE SOCKET AND PLUG, WITHOUT GROUNDING



PS-US



PRZEDŁUŻACZ Z POJEDYNCZYM GNIAZDEM I WTYCZKĄ Z UZIEMIENIEM
EXTENSION CORD WITH SINGLE SOCKET AND PLUG, WITH GROUNDING



PS2-US



PRZEDŁUŻACZ Z PODWÓJNYM GNIAZDEM I WTYCZKĄ Z UZIEMIENIEM
EXTENSION CORD WITH DOUBLE SOCKET AND PLUG, WITH GROUNDING

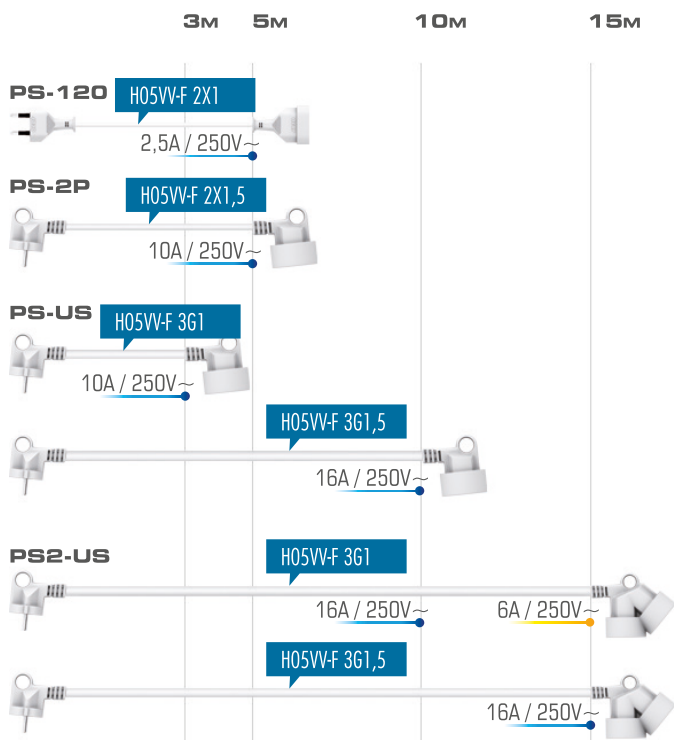

Drogi Kliencie,
zarówno nasze przedłużacze stałe jak i listwy zabezpieczające są produktem specjalnie przygotowanym do zastosowań wewnątrz pomieszczeń. Przedłużacze zapewniają poprawną pracę urządzeń domowych, a listwy zabezpieczające ACAR skutecznie chronią sprzęt codziennego użytku przed niszczącym działaniem prądu. Tłumią one zakłócenia powstałe w sieci elektrycznej. Korzystając z urządzeń ACAR skutecznie zabezpieczasz używany w gospodarstwie domowym sprzęt radiowy i telewizyjny, odbiorniki satelitarne, urządzenia liczące, a także telefony, faksy i sprzęt komputerowy.

Dear Customer,
Universal extension cords as well as surge protectors are products specially designed for indoor use. Extension cords ensure reliable work of home devices and ACAR safety power strips provide effective protection for everyday-use equipment from the destructive effects of overvoltage. They suppress interference generated by power network. The use of ACAR equipment ensures efficient protection for your household appliances, radio and television equipment, satellite receivers, counting equipment, and also telephones, faxes and computers.



PS-120



DESCRIPTION / OPIS	1 GNIAZDO PŁASKIE BEZ UZIEMIENIA FLAT SOCKET WITHOUT GROUNDING	
SOCKET TYPE / TYP		
CABLE / PRZEWÓD	2X0,75 H03VV-F (PVC)	2X0,75 H03VV-F (PVC)
MODEL / EAN	2 M 5907636002680 ○ 3 M 5907636002697 ○ 5 M 5907636002703 ○	2 M 5907636002741 ● 3 M 5907636002758 ● 5 M 5907636002765 ●

PS-2P



DESCRIPTION / OPIS	1 GNIAZDO, BEZ UZIEMIENIA SINGLE SOCKET, WITHOUT GROUNDING	
SOCKET TYPE / TYP		
CABLE / PRZEWÓD	2X1,0 H05VV-F (PVC)	2X1,0 H05VV-F (PVC)
MODEL / EAN	3 M 5907636000846 ○ 5 M 5907636000853 ○	3 M 5907636000914 ● 5 M 5907636000921 ●





PS-US



DESCRIPTION / OPIS	1 GNIAZDO, Z UZIEMIENIEM SINGLE SOCKET, WITH GROUNDING	
SOCKET TYPE / TYP		
CABLE / PRZEWÓD	3G1,5 H05VV-F (PVC)	3G1,0 H05VV-F (PVC)
MODEL / EAN	3 M 5907636001638 ○ - 5 M 5907636001645 ○ - 10 M 5907636001652 ○ -	3 M 5907636001355 ● -

PS2-US





DESCRIPTION / OPIS	2 GNIAZDA, Z UZIEMIENIEM DOUBLE SOCKET, WITH GROUNDING	
SOCKET TYPE / TYP		
CABLE / PRZEWÓD	3G1,5 H05VV-F (PVC)	3G1,0 H05VV-F (PVC)
MODEL / EAN	3 M 5907437082102 ○ - 5 M 5907437082119 ○ - 10 M 5907437082126 ○ -	3 M 5907636005339 ○ - 5 M 5907636005346 ○ - 10 M 5907636005353 ○ -



ACAR xPRO AV

ACAR X5





DESCRIPTION / OPIS	5 GNIAZD OKRĄGŁYCH, Z UZIEMIENIEM, WŁĄCZNIK PODŚWIETLANY 5 ROUND SOCKET, WITH GROUNDING, ILLUMINATED SWITCH		5 GNIAZD OKRĄGŁYCH, Z UZIEMIENIEM, WŁĄCZNIK PODŚWIETLANY 5 ROUND SOCKET, WITH GROUNDING, ILLUMINATED SWITCH	
SOCKET TYPE / TYP	 x5		 x5	
CABLE / PRZEWÓD	3X1,0 H05VV-F (PVC)		3X1,0 H05VV-F (PVC)	
MODEL / EAN	1,5 M 5907636009238 ○	1,5 M ----- ●	1,5 M 5904743525316 ○●	-
	3 M 5907636008828 ○	3 M ----- ●	3 M 5904743525620 ○●	-
	5 M 5907636009252 ○	5 M ----- ●	5 M 5904743525910 ○●	-

ACAR F5

ACAR P7





DESCRIPTION / OPIS	5 GNIAZD OKRĄGŁYCH Z UZIEMIENIEM, WŁĄCZNIK PODŚWIETLANY 5 ROUND SOCKET WITH GROUNDING, ILLUMINATED SWITCH		5 GNIAZD OKRĄGŁYCH Z UZIEMIENIEM, 2 GNIAZDA PŁASKIE, WŁĄCZNIK PODŚWIETLANY 5 ROUND SOCKET WITH GROUNDING, 2 FLAT PLUG, ILLUMINATED SWITCH	
SOCKET TYPE / TYP	 x5		 x5  x2	
CABLE / PRZEWÓD	3X1,0 H05VV-F (PVC)		3X1,0 H05VV-F (PVC)	
MODEL / EAN	1,5 M 5904743285319 ○	-	1,5 M 5904743180010 ○	-
	3 M 5904743285616 ○	-	3 M 5904743180218 ○	-
	5 M 5904743285913 ○	-	5 M 5904743365318 ○	-

ACAR S8

ACAR SMART



DESCRIPTION / OPIS	8 GNIAZD OKRĄGŁYCH Z UZIEMIENIEM, WŁĄCZNIK PODŚWIETLANY 8 ROUND SOCKET WITH GROUNDING, ILLUMINATED SWITCH		6 GNIAZD OKRĄGŁYCH Z UZIEMIENIEM, 2 X WŁĄCZNIK PODŚWIETLANY 6 ROUND SOCKET WITH GROUNDING, 2 X ILLUMINATED SWITCH	
SOCKET TYPE / TYP	 x8		 x6	
CABLE / PRZEWÓD	3X1,0 H05VV-F (PVC)		3X1,0 H05VV-F (PVC)	
MODEL / EAN	1,5 M 5904743285319 ○	-	1,5 M 5904743390013 ○	-
	3 M 5904743285616 ○	-	3 M 5904743390310 ○	-
	5 M 5904743285913 ○	-		

MINI AXON A310



DESCRIPTION / OPIS	1 GNIAZDO OKRĄGŁE Z UZIEMIENIEM, 2 GNIAZDA PŁASKIE 1 ROUND SOCKET WITH GROUNDING, 2 FLAT PLUG	
SOCKET TYPE / TYP	 x2	
CABLE / PRZEWÓD	-	
MODEL / EAN	5904743353018 ○	



4.1 PRZEWODY PRZYŁĄCZENIOWE PVC POWER CORDS - PVC

4.2 PRZEWODY PRZYŁĄCZENIOWE GUMA POWER CORDS - RUBBER

Przewody przyłączeniowe,

Firma Acar S.A. to również wiodący producent przewodów przyłączeniowych dla potrzeb przemysłu.

W swojej ofercie przewodów przyłączeniowych posiada zarówno przewody w oponie polwinilowej jak i gumowej cieszące się szczególnym powodzeniem wśród producentów, dystrybutorów, serwisantów elektronarzędzi.

Produkty wyróżnia sposób wyprowadzenia przewodu (prosty, boczny) oraz rodzaj wtyczki (okrągła, płaska.). Tak jak wszystkie produkty ACAR również przewody przyłączeniowe z wtyczką okrągłą charakteryzuje ergonomiczny uchwyt ułatwiający jej włączenie i rozłączenie. Wszystkie produkty posiadają stopień ochrony IP-20.

Asortyment firmy obejmuje następujące wyroby:

- SPZ-US (wtyczka z uchwytem, kątowne wyprowadzenie przewodu, opona PVC bądź gumowa, przewód uziemiający, I klasa izolacji)
- SPZ-2P (wtyczka z uchwytem, kątowne wyprowadzenie przewodu, opona PVC bądź gumowa, II klasa izolacji)
- SPZ-2P/P (wtyczka z uchwytem, proste wyprowadzenie przewodu, opona PVC bądź gumowa, II klasa izolacji)
- SPZ-79 (wtyczka płaska, opona PVC, II klasa izolacji)
- SPZ-PZ (wtyczka płaska, opona PVC, cewka przeciwzakłóceńowa)
- ACARIUS SPZ-US (wtyczka z uchwytem, opona PVC, przewód uziemiający, gniazdo komputerowe).

Przewody dostępne są w standardowych kolorach: białym, czarnym. Istnieje możliwość wykonania w innym kolorze na życzenie klienta. Długości przewodów ustalane są indywidualnie z klientem.

Jakość produktów potwierdzają certyfikaty uprawniające do oznaczania wyrobu znakiem bezpieczeństwa oraz Certyfikat Jakości ISO 9001:2008.

Service cables,

ACAR S.A. is also a leading manufacturer of service cables for industrial purposes.

The offer of service cables includes both cables in PVC and rubber insulations which are particularly in demand by manufacturers, distributors and servicemen of electric tools.

The products are distinguished by the way the cable exits the body (straight, sidewise) and the type of plug (round, flat). Similar to all ACAR products the service cables with round plug are characteristic through their ergonomic grip which facilitates connection and disconnection. All products are of IP 20 protection grade.

Product lines of our company include the following:



- SPZ-US (plug with a grip, angled cable outlet, PVC or rubber insulation, earthing cable, insulation class: I)
- SPZ-2P (plug with a grip, angled cable outlet, PVC or rubber insulation, insulation class: II)
- SPZ-2P/P (plug with a grip, angled straight cable outlet, PVC or rubber insulation, insulation class: II)
- SPZ-79 (flat plug, PVC insulation, insulation class: II)
- SPZ-PZ (flat plug, PVC insulation, interference suppression coil)
- ACARIUS SPZ-US (plug with a grip, PVC insulation, earthing cable, computer socket).

Cables are available in standard colours: white, black. Other colours available on customer's request. Cable lengths are agreed individually with customers.

Quality of products is confirmed by certificates, which authorize to label the products with safety mark, and ISO 9001:2008 Quality Certificate.



SPZ-79



DESCRIPTION / OPIS	1 WTYCZKA PŁASKA BEZ UZIEMIENIA SINGLE PLUG WITHOUT GROUNDING	
SOCKET TYPE / TYP	 	
CABLE / PRZEWÓD	2X0,75 H03VVH2-F (PVC)	2X0,75 H03VVH2-F (PVC)
MODEL / EAN	1,5 M 5907636000181 ○ - 2,5 M 5907636000211 ○ - 3,1 M 5907636000235 ○ -	1,5 M 5907636000242 ● - 2,5 M 5907636000273 ● - 3,1 M 5907636000297 ● -

SPZ-79/P



DESCRIPTION / OPIS	1 WTYCZKA PŁASKA BEZ UZIEMIENIA, WŁĄCZNIK SINGLE PLUG WITHOUT GROUNDING, SWITCH	
SOCKET TYPE / TYP	 	
CABLE / PRZEWÓD	2X0,75 H03VVH2-F (PVC)	2X0,75 H03VVH2-F (PVC)
MODEL / EAN	1,5 M 5907437081952 ○ - 2,5 M 5907636000648 ○ - 3,1 M 5907636000662 ○ -	1,5 M 5907636000686 ● - 2,5 M 5907636000723 ● - 3,1 M 5907636000747 ● -

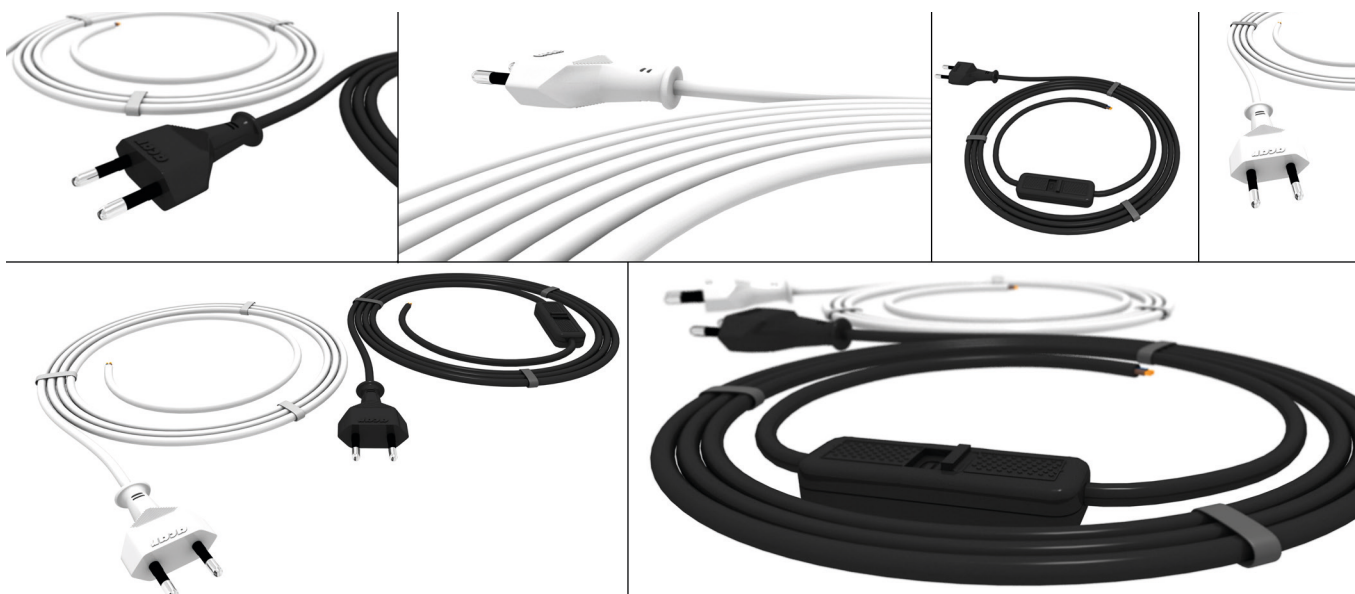

SPZ-US / ACARIUS

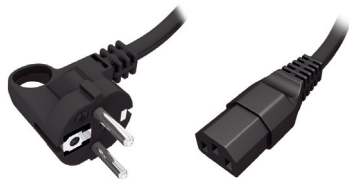

DESCRIPTION / OPIS	1 WTYCZKA OKRĄGŁA Z UZIEMIENIEM SINGLE ANGULAR PLUG WITH GROUNDING
SOCKET TYPE / TYP	
CABLE / PRZEWÓD	3G0,75 H05VV-F (PVC)
MODEL / EAN	2,5 M 5907636008323 ● -

SPZ-US



DESCRIPTION / OPIS	1 WTYCZKA OKRĄGŁA Z UZIEMIENIEM SINGLE ANGULAR PLUG WITH GROUNDING	
SOCKET TYPE / TYP		
CABLE / PRZEWÓD	3X1,0 H05VV-F (PVC)	3X1,0 H05VV-F (PVC)
MODEL / EAN	1,5 M 5907437080825 ○ - 2,5 M 5907437080832 ○ - 3,0 M 5907437080849 ○ - 4,0 M 5907437082188 ○ - 4,5 M 5907437082164 ○ -	1,5 M 5907437080856 ● - 2,5 M 5907437080863 ● - 3,0 M 5907437080870 ● - 4,0 M 5907437082195 ● - 4,5 M 5907437082171 ● -
CABLE / PRZEWÓD	3G1,5 H05VV-F (PVC)	3G1,5 H05VV-F (PVC)
MODEL / EAN	3,0 M 5907437080887 ○ - 4,0 M 5907437082225 ○ - 4,5 M 5907437082201 ○ -	3,0 M 5907437080894 ● - 4,0 M 5907437082232 ● - 4,5 M 5907437082218 ● -





SPZ-2P/P



DESCRIPTION / OPIS	1 WTYCZKA OKRĄGŁA BEZ UZIEMIENIA SINGLE ANGULAR PLUG WITHOUT GROUNDING	
SOCKET TYPE / TYP		
CABLE / PRZEWÓD	2X1,5 H05RR-F (GUMA/RUBBER)	2X1,0 H05RR-F (GUMA/RUBBER)
MODEL / EAN	3,0 M 5907437086131 ● - 4,0 M 5907437086124 ● - 4,5 M 5907437086643 ● -	3,0 M 5907437088166 ● - 4,0 M 5907636006900 ● - 4,5 M 5907636006831 ● -
CABLE / PRZEWÓD	2X1,5 H07RN-F (GUMA/RUBBER)	2X1,0 H07RN-F (GUMA/RUBBER)
MODEL / EAN	3,0 M 5907437080948 ● - 4,0 M 5907437080955 ● -	3,0 M 5907437080917 ● - 4,0 M 5907437080924 ● -
CABLE / PRZEWÓD	2X1,5 H07BQ-F (POLIURETAN/POLYURETHANE)	2X1,0 H05BQ-F (POLIURETAN/POLYURETHANE)
MODEL / EAN	4,0 M 5907437087954 ● -	4,0 M 5907437087947 ● -

SPZ-US



DESCRIPTION / OPIS	1 WTYCZKA OKRĄGŁA Z UZIEMIENIEM SINGLE ANGULAR PLUG WITH GROUNDING	
SOCKET TYPE / TYP		
CABLE / PRZEWÓD	3G1,5 H05RR-F (GUMA/RUBBER)	3G1,0 H05RR-F (GUMA/RUBBER)
MODEL / EAN	3,0 M 5907437087190 ● - 4,5 M 5907437082591 ● -	3,0 M 5907437080979 ● - 4,5 M 5907437082607 ● -



SPZ-US/44



DESCRIPTION / OPIS	1 WTYCZKA OKRĄGŁA Z UZIEMIENIEM, IP44 SINGLE ANGULAR PLUG WITH GROUNDING, IP44	
SOCKET TYPE / TYP		
CABLE / PRZEWÓD	3G2,5 H05RR-F (GUMA/RUBBER)	3G1,5 H05RR-F (GUMA/RUBBER)
MODEL / EAN	5,0 M 5907437087732 ● -	3,0 M 5907437088210 ● - 4,5 M 5907437088227 ● -
CABLE / PRZEWÓD	3G1,0 H05RR-F (GUMA/RUBBER)	
MODEL / EAN	3,0 M 5907437088142 ● - 4,5 M 5907437088203 ● -	

G-330





DESCRIPTION / OPIS	3 X GNIAZDO Z KLAPKĄ Z UZIEMIENIEM, IP44 3 X SOCKETS WITH COVER, WITH GROUNDING, IP44
MATERIAL / MATERIAL	PVC
SOCKET TYPE / TYP	 x3
MODEL / EAN	5907437087183 

FAZER 777



FAZER 767



DESCRIPTION / OPIS	JEDNOBIEGUNOWY, WIELOFUNKCYJNY PRÓBNIK NAPIĘCIA Z WYKRYWANIEM PRZEWODÓW BĘDĄCYCH POD NAPIĘCIEM ELECTRICAL TESTER, WITH VOLTAGE DETECTOR	JEDNOBIEGUNOWY PRÓBNIK NAPIĘCIA ELECTRICAL TESTER
MODEL / EAN	5901182000022  -	5901182000015  -

